

Tango G2 LED



Tango G2 LED is a general purpose LED flood lighting luminaire for various lighting applications, such as area lighting, bill-board, façade, industry area, recreational sports and other general applications. The Tango G2 LED flood light incorporates LED light source, optical system, heat sink and driver into one compact housing. Its specially designed heat sink incorporates aesthetics and functionality to ensure reliability and long lifetime. Tango G2 LED takes advantage of LED technology which provides energy savings and a longer lifetime, bringing area lighting into a new era.

Features & Benefits

- **Energy saving:** system efficacy reaches 100lm/w, which gives more than 40% of energy saving when compared to conventional floodlight
- **Free from lamp replacement:** Lifetime reaches 50,000 hours at L70, which requires no lamp replacement after installation
- **Low maintenance cost:** IP65 housing ensures low maintenance with no need for internal cleaning, resulting in a lower total cost of ownership
- **Flexibility on lighting application:** Optical beam choice of symmetric and asymmetric fulfills majority needs of lighting application
- **Good reliability:** Painted non-corrosive die-cast aluminum housing and steel bracket gives extra strength when the luminaire is installed in a rough environment
- **Easy installation and maintenance:** Universal “U” shape mounting bracket.



PHILIPS

Tango G2 LED

Specifications

	Tango G2 LED
Type	BVP281
Light source	Mid Power LED
Power requirement	220-240V 50/60Hz
Power factor	0.95
Power Consumption	40W; 80W; 120W
LED driver & driving current	Constant current at 700mA
System lumen output	4,000; 8,000; 12,000 lumen
CRI	Min. 80
Color temperature	6500K ± 500K / 4000K ± 500K
Optics	AMB – Asymmetric, SWB – Symmetric
Materials and finishing	Housing: Die-cast aluminum (ADC1) Gasket: Heat resistant silicone rubber Glass: Tempered glass Housing Colour: Grey Aluminium RAL9007
Lifetime	50,000 hours (70% lumen maintenance @ Ta = 35°C)
Installation	Universal Bracket
Dimensions (LxBxH)	370 x 360 x 60mm
Weight	6.0 – 6.5 kg
Classifications	IP65; IK07; Class I; RoHS
Operating Temperature	-40°C to 45°C (Outdoor)
Surge protection	10KV
Controls	Optional - DALI & 1-10V Dimming (ETO)
Certifications	CB, CQC, AS/NZ

Tango G2 LED

Dimensions
(units: mm)

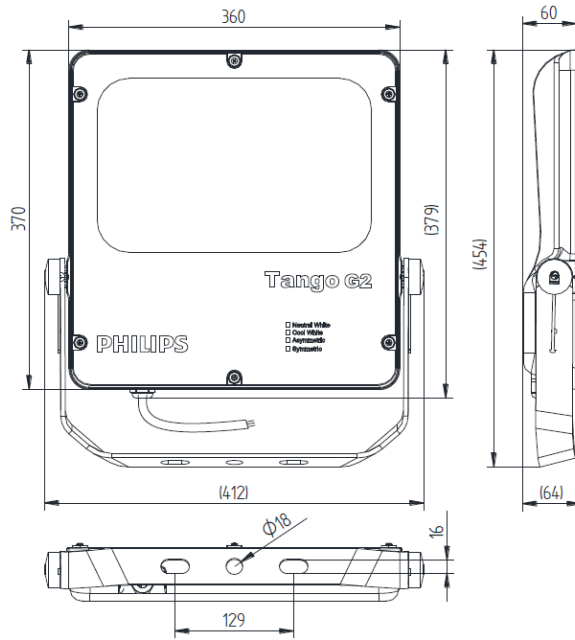

Photometry

BVP281 LED40/NW 40W 220-240V AMB
1 x 4000 lm
L.O.R : 1.00

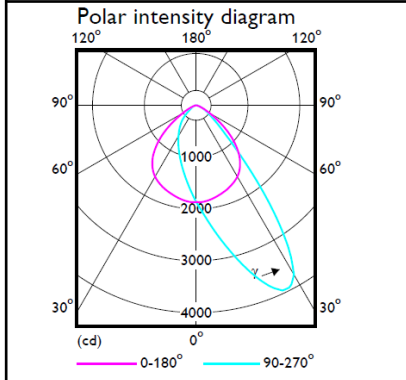

BVP281 LED80/NW 80W 220-240V AMB
1 x 8000 lm
L.O.R : 1.00

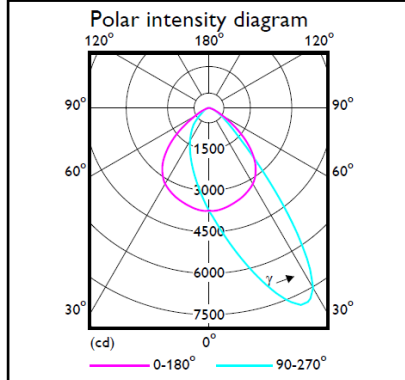

BVP281 LED120/NW 120W 220-240V AMB
1 x 12000 lm
L.O.R : 1.00

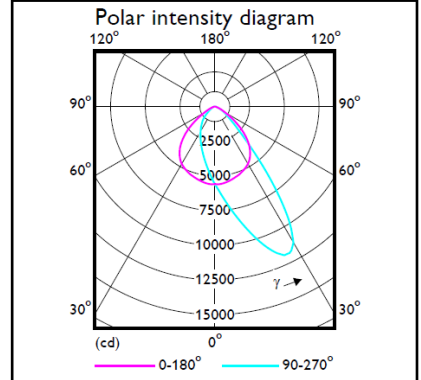

BVP281 LED40/NW 40W 220-240V SWB
1 x 4000 lm
L.O.R : 1.00

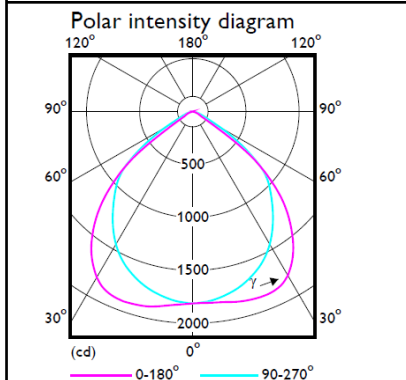

BVP281 LED80/NW 80W 220-240V SWB
1 x 8000 lm
L.O.R : 1.00

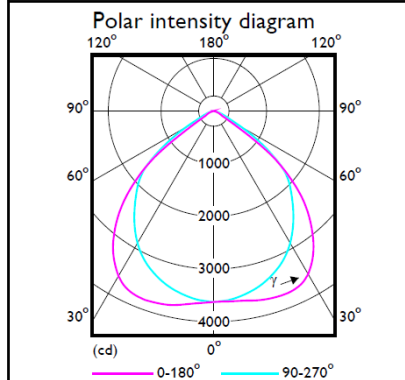

BVP281 LED120/NW 120W 220-240V SWB
1 x 12000 lm
L.O.R : 1.00

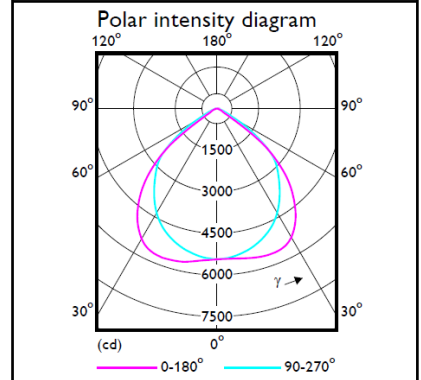

Tango G2 LED

Ordering information

12NC	Description
911401635202	BVP281 LED40/NW 40W 220-240V SWB
911401634102	BVP281 LED80/NW 80W 220-240V SWB
911401634202	BVP281 LED120/NW 120W 220-240V SWB
911401634302	BVP281 LED40/NW 40W 220-240V AMB
911401634402	BVP281 LED80/NW 80W 220-240V AMB
911401634502	BVP281 LED120/NW 80W 220-240V AMB
911401634602	BVP281 LED40/CW 40W 220-240V SWB
911401634702	BVP281 LED80/CW 80W 220-240V SWB
911401634802	BVP281 LED120/CW 120W 220-240V SWB
911401634902	BVP281 LED40/CW 40W 220-240V AMB
911401635002	BVP281 LED80/CW 80W 220-240V AMB
911401635102	BVP281 LED120/CW 120W 220-240V AMB

- More options available on request



© 2013 Koninklijke Philips N.V.
All rights reserved.

Specifications are subject to change without notice. Trademarks are the property of Koninklijke Philips N.V. or their respective owners.

www.philips.com/lighting

October 2013
Data subject to change